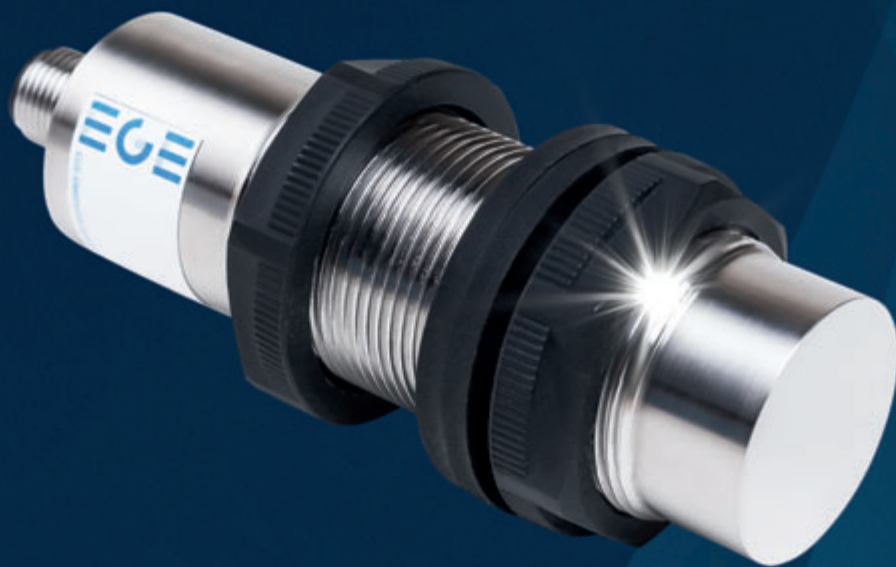

Brochure No. 7.3

 **Ultrasonic Sensors****Special-Sensors for Automation**

Ultrasonic Sensors

Technique & Application

Application note

Basics

Ultrasonic sensors are transmitting and receiving ultrasonic signals. These signals have a frequency range from 65 kHz up to 300 kHz. Ultrasonic sensors can be used for several different applications, for example:

- diameter detection
- looptension
- height detection
- level measuring
- counting

Application notes

Non-contact detection of:

- distances
- presence
- level
- diameter
- position

Independent of:

- material
- colour
- light
- smoke
- dust

Cycle period

A short ultrasonic pulse is transmitted at the time 0, reflected by an object. The sensor receives this signal and converts it to an electric signal. The next pulse can be transmitted when the echo is faded away. This time period is called cycle period. (Fig. 1)

Sensors with

- long sensing ranges have long cycle periods and slow reaction time.
- short sensing ranges have short cycle periods and fast reaction times.

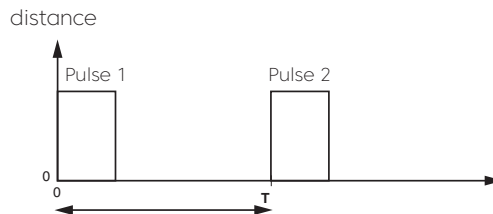

Fig. 1: cycle period T

Angle of beam

The energy of the ultrasonic pulse is transmitted in form of a cone along the transducer axis. The highest intensity is on the axis and decreases with rising angles. The angle of beam is defined by the angle through which the energy of the ultrasonic pulse is reduced of 33% of its maximum value. The best detection is given by an object that stands vertical to the transducer axis. To give a save detection, the object should not have an greater angle than half of the angle of beam ($\alpha/2$). (Fig. 2) If the object is canted at a greater angle, there is no reflection of the ultrasonic pulses. An object with a flat surface and canted at an angle of 45° to the transducer axis refracts the ultrasonic pulse in an angle of 90°. An ultrasonic pulse can be compared to a light beam.

Acoustic beam width α



Abb. 2: angle of beam

Voltage amplitude

During the transmission the voltage amplitude of the ultrasonic pulse is approximate 80 V PP. The pulse period of the ultrasonic pulse depends on the duration of the transmission pulse and on the ringing time of the transducer. The voltage amplitude of the received echo is in the range of μ V. (Fig. 3)

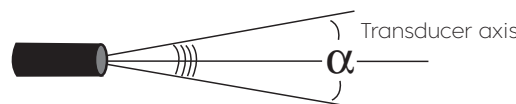

Fig. 3: voltage amplitude

Blind zone

It is not possible to receive an echo during the transmission of the ultrasonic pulse. This time period defines the range of the blind zone. In this blind zone it is not possible to measure a distance. (Fig. 4)

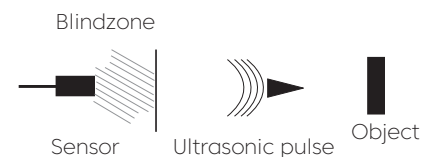

Fig. 4: Blindzone



With switching point

Plastic miniature housing

DC 18...30 V

PNP output

Teach-in programming



Design **DC PNP • rectangular housing 26x40x12**

Dimensions

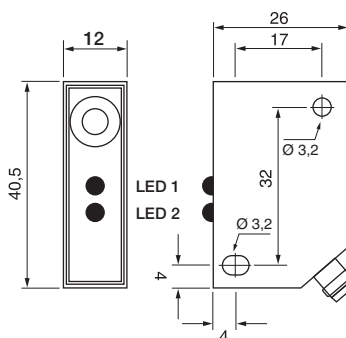

Sensing range	[mm]	25...250
Output		
ID-No.		P72026
Type		ARKS 250 GPP
Supply voltage	[V]	18...30 DC
Current consumption	[mA]	35
Switching current	[mA]	100
Switching frequency	[Hz]	50
Ambient temperature	[°C]	-20...+70
Protection	[EN 60529]	IP 67
Housing material		PBTP
Connection		M8 connector

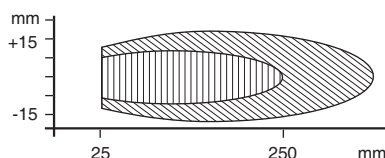

mögliche Erfassung eines großen Objektes
Possible detection of a large target

Sichere Erfassung eines großen Objektes
Save detection of a large target

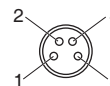
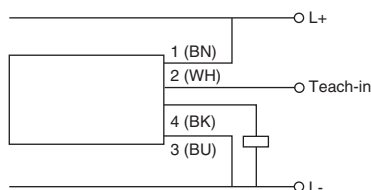

Accessories **M8 plug type connection, 2 m PVC-cable is part of delivery**



With switching point

Metal / plastic thread
 M12x1
 M18x1
 M30x1.5

DC 18...30 V

Sensing range adjustable



Design	DC PNP • M12x1	DC PNP • M18x1		DC PNP • M30x1.5
Dimensions				
Sensing range [mm]	25...200	100...800	80...1600	300...3000
Output				
ID-No.	P72018	P72030	P72031	P72003
Type	AGKU 200 GPP	AGKU 800 GSOP	AGKU 1600 GSOP	AGKU 3000 GSP
Supply voltage [V]	10...30 DC	12...30 DC	12...30 DC	18...30 DC
Switching current [mA]	100	500	500	400
Short circuit proof	•	•	•	•
Reverse protection	•	•	•	•
Switching frequency [Hz]	50	10	6	1
Ambient temperature [°C]	-15...+70	-20...+70		-15...+70
Protection [EN 60529]	IP 67	IP 67		IP 67
LED display	•	•		•
Housing material	AISI 316 Ti	PBTP		PBTP
Connection	M12 connector			

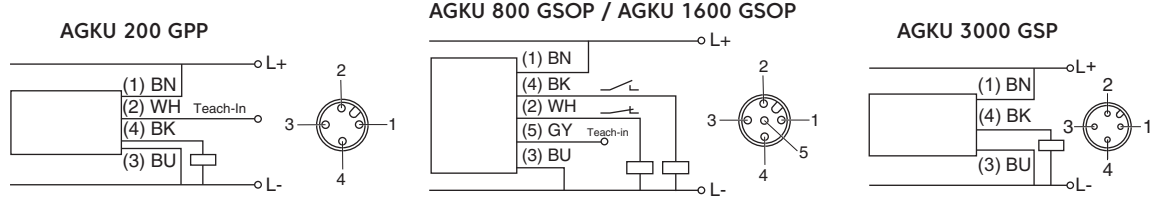
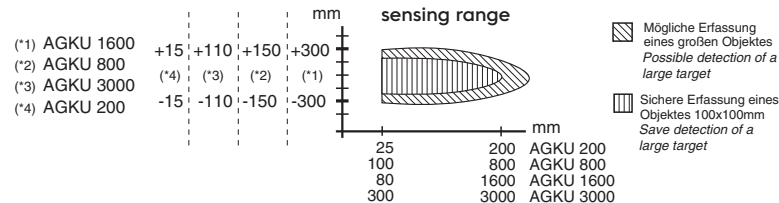

Accessories Connecting type SLG 4-2 (Z00445), SLG 3-2 (Z01076), SLG 5-2 (Z01150)



Switching points and analog output

Plastic thread
M18x1
M30x1.5

DC 18...30 V

Two switching points PNP
Sensing range adjustable



Design	Teach-in • M30x1.5	4...20 mA • M30x1.5	4...20 mA • M18x1
Dimensions			
Sensing range [mm]	250...2000	300...2500	200...1500
Output	2x		
ID-No.	P72005	P72011	P72010
Type	AGKU 2000 GIPP	AGKU 2500 GI	AGKU 1500 GI
Supply voltage [V]	19...30 DC	18...30 DC	18...30 DC
Current consumption [mA]	25	35	35
Load current [mA]	100	-	-
Current output [mA]	-	4...20	-
Load resistance R_L [Ω]	-	0...500	-
Linear deviation [%]	-	0.5	-
Ambient temperature [$^{\circ}\text{C}$]	-	-15...+70	-
Temperature drift [%]	-	0.5	-
Protection [EN 60529]	-	IP 67	-
Housing material	-	PBTP	-
Connection	M12 connector		
	<p>AGKU 2000 GIPP</p>	<p>AGKU GI</p>	<p>AGKU 1500 GI</p>
Accessories	Connecting type SLG 5-2 (Z01150), SLG 3-2 (Z01076)		



Metal face sensors | Switching point

M30
One piece stainless steel housing

DC 18...30 V

PNP output
Teach-in programming



Design Teach-in • M30x1.5

Dimensions

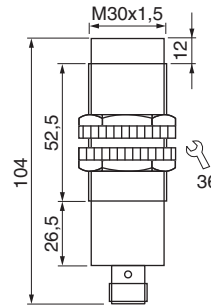

Sensing range [mm]	150...1500
Output	
ID-No.	P72033
Type	AGVU 1500 GSP
Supply voltage [V]	18...30 DC
Current consumption [mA]	< 40
Switching current [mA]	500
Repeatability [%]	±0.2
Switching frequency [Hz]	7
Ambient temperature [°C]	-15...+70
Protection [EN 60529]	IP 68 + IP 69
Housing material	AISI 316 Ti
Connection	M12 connector

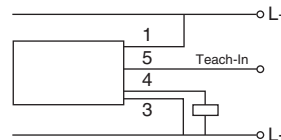
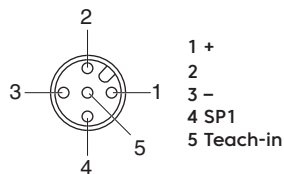
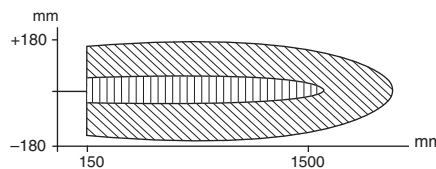

Accessories Connecting cable type SLG 5-2 (Z01150)



Metal face sensors | Analog output

M30
One piece stainless steel housing

DC 18...30 V

Analog output
Sync input



Design M30x1.5

Dimensions

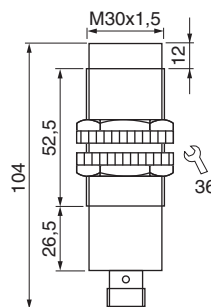

Sensing range	[mm]	150...1500
Output		
ID-No.		P72034
Type		AGVU 1500 GI
Supply voltage	[V]	18...30 DC
Current consumption	[mA]	< 40
Current output	[mA]	4...20
Load resistance R _L	[Ω]	0...500
Linear deviation	[%]	< 0.3
Repeatability	[%]	±0.2
Ambient temperature	[°C]	- 15...+70
Protection	[EN 60529]	IP 68 + IP 69
Housing material		AISI 316 Ti
Connection		M12 connector

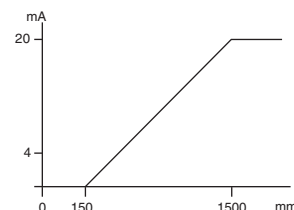
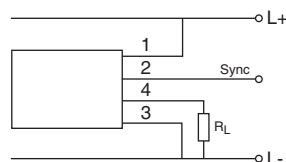
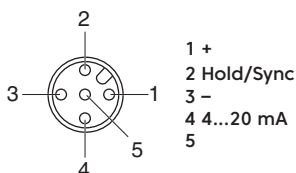
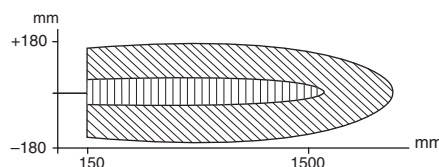

Accessories Connecting cable type SLG 5-2 (Z01150)



Two switching points

Rectangular housing 100x36 mm

DC 12...30 V

Two independent switching points
Teach-in programming
Sync input



Design **DC PNP • rectangular housing 100x36**

Dimensions

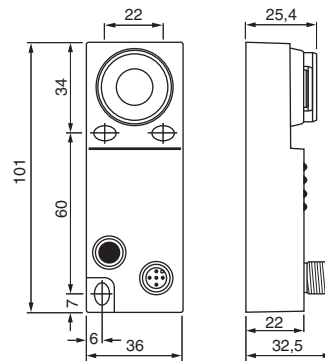

Sensing range [mm]	30...400	100...800	300...3500
Output	2x	2x	2x
ID-No.	P72020	P72021	P72022
Type	ARKU 400 GPP	ARKU 800 GPP	ARKU 3500 GPP
Supply voltage [V]	12...30 DC		
Current consumption [mA]	35		
Switching current [mA]	400		
Repeatability [%]	0.2	0.1	0.2
Ambient temperature [°C]	-15...+70		
Protection [EN 60529]	IP 67		
Housing material	PBTP		
Connection	M12 connector		

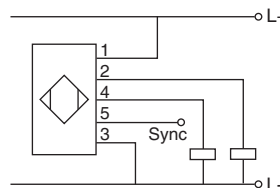
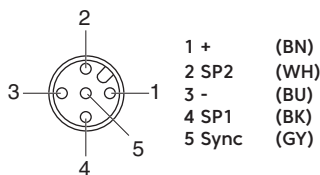
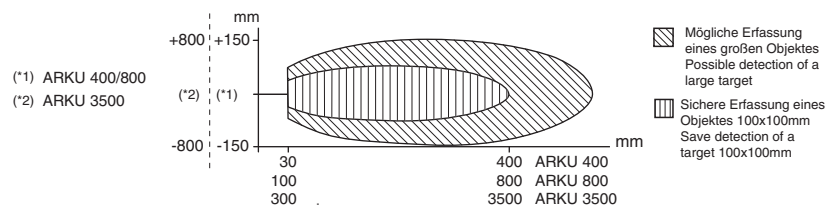

Accessories **Connecting cable type SLG 5-2 (Z01150), SLW 5-2 (Z01151)**



Analog output

Rectangular housing 100x36 mm

DC 15...30 V
4...20 mA

Teach-in programming
Sync input



Design **4...20 mA • rectangular housing 100x36**

Dimensions

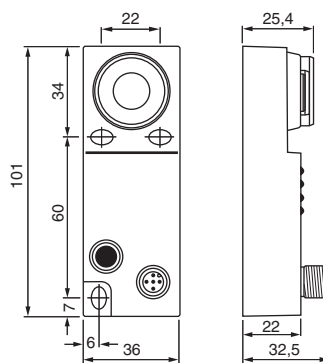

Sensing range [mm]	30...400	100...800	300...3500
Output			
ID-No.	P72023	P72024	P72025
Type	ARKU 400 GI	ARKU 800 GI	ARKU 3500 GI
Supply voltage [V]	15...30 DC		
Current consumption [mA]	40		
Current output [mA]	4...20		
Repeatability [%]	±0.2		
Ambient temperature [°C]	-15...+70		
Protection [EN 60529]	IP 67		
Housing material	PBTP		
Connection	M12 connector		

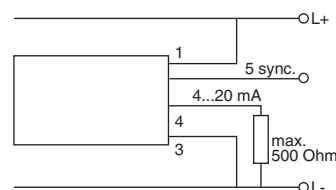
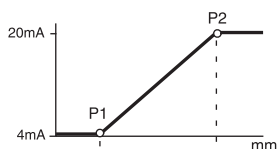
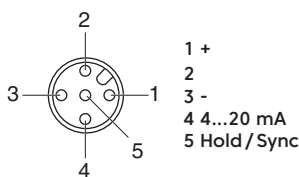
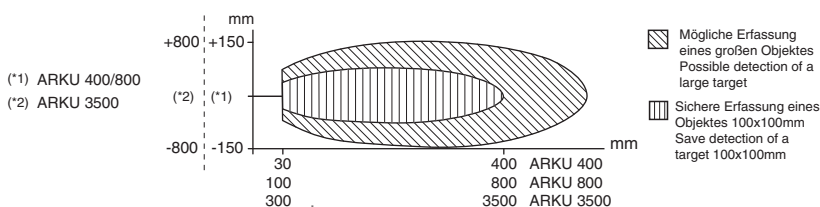

Accessories **Connecting cable type SLG 5-2 (Z01150), SLW 5-2 (Z01151)**



Ultrasonic thru scan

Rectangular housing
30x20x12 mm

DC 18...30 V

High switching frequency



Design **DC PNP • rectangular housing 30x20x12**

Dimensions

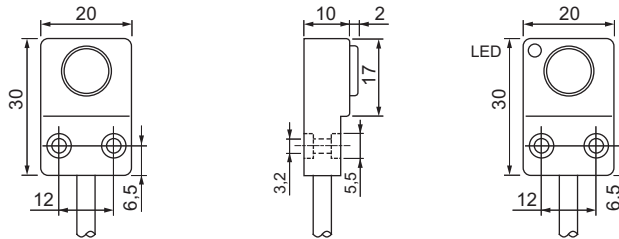

Sensing distance max. [mm]	0...300	
Function	Transmitter	Receiver
Output		
ID-No.	P72029	
Type	ARK 300 GSP	
Supply voltage [V]	18...30 DC	
Current consumption [mA]	< 40	
Switching current [mA]	500	
Switching frequency [Hz]	150	
Ambient temperature [°C]	-15...+60	
Protection [EN 60529]	IP 67	
Housing material	ABS	
Connection	2 m cable	

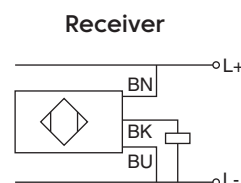
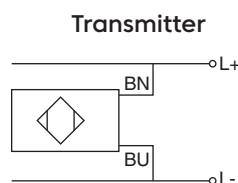
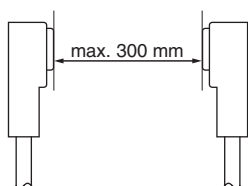

Process Sensors

Flow sensors

- Electronical monitoring of flow
- Lubrication monitoring
- Measuring range 1 ml/min...100 l/min
- Detection range 1...300 cm/s
- Reaction time 0.5 s

Level sensors

- For level monitoring – 230...+230 °C
- Steam proof at a pressure of up to 30 bar
- For hot motor oil
- For liquid nitrogen
- For chemically aggressive media

Pressure sensors

- Monitoring in pipes and containers
- Pressure up to 16 bar
- Level up to 10 m (± 1 cm)
- Compact model with digital display
- Programmable

Temperature sensors

- Monitoring in pipes and containers
- Temperature – 40...+120 °C ($\pm 0,3$ °C)
- Pressure up to 100 bar
- Compact model with digital display
- Multi use output NO/NC + analog

Infrared detectors

- Measurement of temperature
- Monitoring of hot media
- Position control

Metal detectors

- Detection of metal parts
- For harsh environment
- Large sensing range up to 400 mm
- Monitoring of bulk materials
- Machine protection



Sales partners, wholesalers and representatives



ARGENTINA, Lomas de Zamora
AUSTRALIA, Warabrook NSW 2304
AUSTRIA, Wien
BELGIUM, Aalst
BRAZIL, Sao Paulo
CANADA, Oldcastle – Ontario
CHINA, Shanghai
COLOMBIA, Bogota D.C.
CZECH REPUBLIC, Ostrava
DENMARK, Aabenraa
ESTONIA, Tallinn
FINLAND, Jyväskylä
FRANCE, Nanteuil les Meaux
GREECE, Sindos - Thessaloniki

GREAT BRITAIN, Staffordshire
HUNGARY, Budapest
INDIA, Mumbai
IRELAND, Clane, Co. Kildare
ISRAEL, Tel-Aviv
ITALY, Carate Brianza (MI)
JAPAN, Tokyo
NAMIBIA, Windhoek
NETHERLANDS, LG Dordrecht
NEW ZEALAND, Greenmount,
Auckland
NORWAY, Kolsås
PHILIPPINES, Taguig City
POLAND, Jezow Sudecki
POLAND, Katowice

RUSSIAN FEDERATION, Moscow
PORTUGAL, Porto
ROMANIA, Bucharest
SINGAPORE, Singapore
SLOVAKIA, Banská Bystrica
SLOVENIA, Ljubljana - Crnuce
SOUTH AFRICA, Cleveland
SOUTH KOREA, Gwangmyeongsi,
Gyeonggi-do
SPAIN, Nigran
SWEDEN, Borås
SWITZERLAND, Uster
TAIWAN, New Taipeh City
TURKEY, Kurtköy / Pendik / Istanbul
USA, Gastonia
VIETNAM, Ho Chi Minh City



<https://ege-elektronik.com/en/organisation/ege/>

We look forward to your enquiry.
Please contact us!

EGE-Elektronik
Spezial-Sensoren GmbH
Ravensberg 34 • 24214 Gettorf • Germany
T +49 (0) 4346-41580 F +49 (0) 4346-5658
info@ege-elektronik.com
ege-elektronik.com

EU71120

